

Culture media preparators

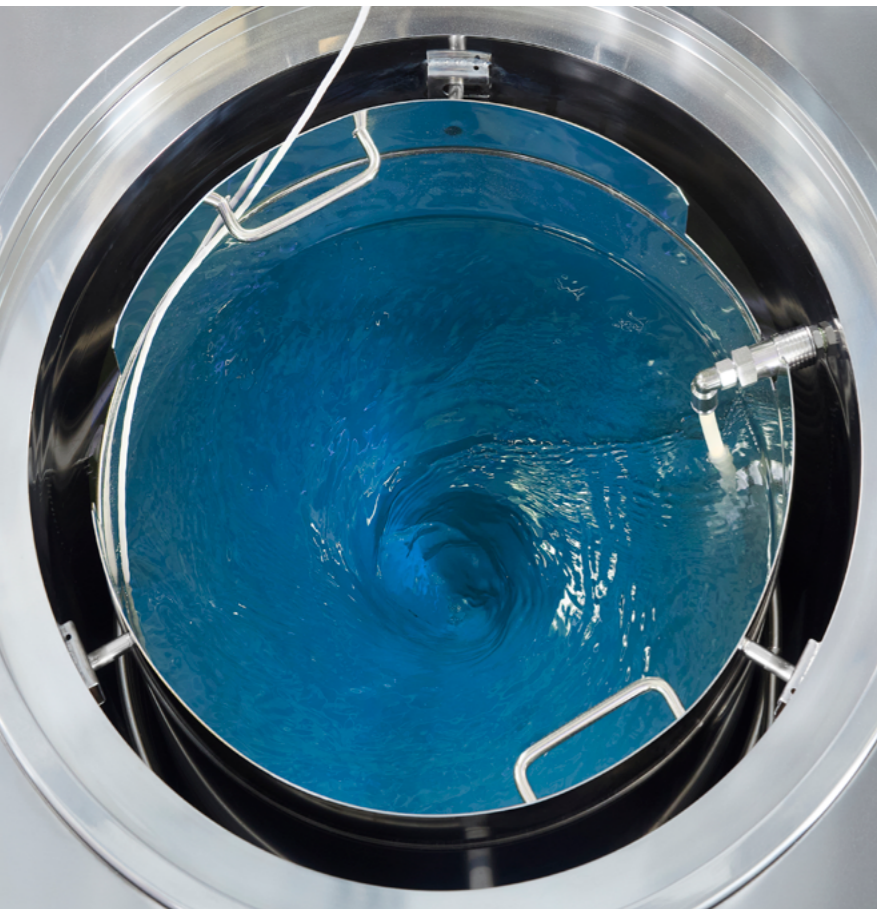





Culture media preparators

The most efficient solution for a fast and safe preparation of culture media







5 processes streamlined in 1 solution





-  Preparation
-  Sterilization
-  Fast cooling
-  Dispensing
-  Cleaning of lines



Applications

-  Preparation of specific media for plant tissue culture
-  Preparation of high-density enriched media for fungal culture
-  Preparation of agar
-  Preparation of lysogeny broth
-  Preparation of buffer solutions

Fields

-  Plant tissue culture laboratories
-  Stem cell culture laboratories
-  Microbiology laboratories
-  Clinical analysis laboratories

"All the necessary functions to satisfy a wide variety of applications"



Professional reproducibility

By performing a single weighing and processing the entire preparation under identical conditions, much better precision and reproducibility are achieved.



Perfect homogeneity

Achieves even mixing of all elements in the medium by leveraging the built-in continuous stirring system of the equipment. This system allows for speed adjustment to suit a range of demands.



Accurate control of temperature

A PT-100 flexible temperature probe continuously measures the medium's temperature, enabling the microprocessor to regulate the cycle based on temperature or directly through lethality using the F_0 value.



Time savings

The integration of multiple functions into a single device, along with the fast cooling system, allows for increased productivity and optimized workflow.



Advanced safety

Our designs prioritize user safety and comfort, incorporating features such as automatic door locking, thermally insulated covers, casters for ease of transportation and alarm systems that notify of malfunctions or cycle completion alerts.



Reduction of human error

By greatly reducing the need for human intervention, we eliminate the usual errors associated with manual operations like imprecise measurements, omitted steps, and operator technique discrepancies.

"Streamline the operational workflow of your laboratory"

Advantages of our media preparators over an autoclave

Autoclave

RAYPA Media Preparator

Preparation

The procedure for each container includes repetitive hand-operated steps such as weighing, filling with water, and mixing. Issues emerge regarding the dissolution and the uniformity of the solution's concentration and volume.

A single operation of weighing and water filling, coupled with constant stirring and precise automated dispensing, achieves perfect solubility, uniform concentration, and equal volume across all containers.

Heating and sterilization

Low-wattage equipment that slowly heat the medium. The lack of stirring results in uneven temperatures among the containers, increasing the risk of overheating or ineffective sterilization. The absence of internal temperature control in the containers impedes the assessment of the process's efficacy.

Overpowered equipment rapidly heats the medium. The level of sterility achieved is the same at all points of the preparation. The use of a PT-100 flexible temperature probe for direct temperature monitoring enables quantification of lethality and ensures full traceability of every process.

Cooling

Very long cooling phase. After opening the door, the exact temperature of the containers is unknown, with the consequent risk of burns. Thermolabile nutrients or antibiotics cannot be injected. The overexposure to heat adversely affects the fertility of the culture media.

Fast cooling system using a water coil that reduces cooling time by up to 90%. Thermolabile nutrients or antibiotics can be injected at any time and enables the configuration of cycles with additional warming intervals.

Dispensing

Manual and individual dispensing in each container. Dispensing temperature not controllable. Notable lack of speed. Lack of homogeneity in volume between containers. Scaling up productivity in response to increased demand is challenging.

Automated dispensation is executed at the required temperature, achievable at varying speeds, both rapid and slow. Perfect volume homogeneity between containers. Multiple dispensing methods available and supports the integration of external dispensers, enabling productivity to scale according to demand.

Safety

Risk of burns from hot flasks, breakage of containers inside the autoclave and solidification of the preparation during dispensing.

Ergonomic design, total safety for the operator, multiple automatic functions, and minimal risk of cross-contamination.

Cleaning

Difficult and laborious. Manual cleaning of each container and of the dispensing system used.

Significant time is saved through the chamber's and dispensing lines' various automatic self-cleaning functions. Inner vessel with handles for comfortable removal.



Understanding the operation of our media preparators

Our media preparators feature an advanced sterilization system that includes three key phases: heating, sterilization and fast cooling. This process not only ensures the effective elimination of all microorganisms, but also drastically boosts the laboratory's time management and productivity.

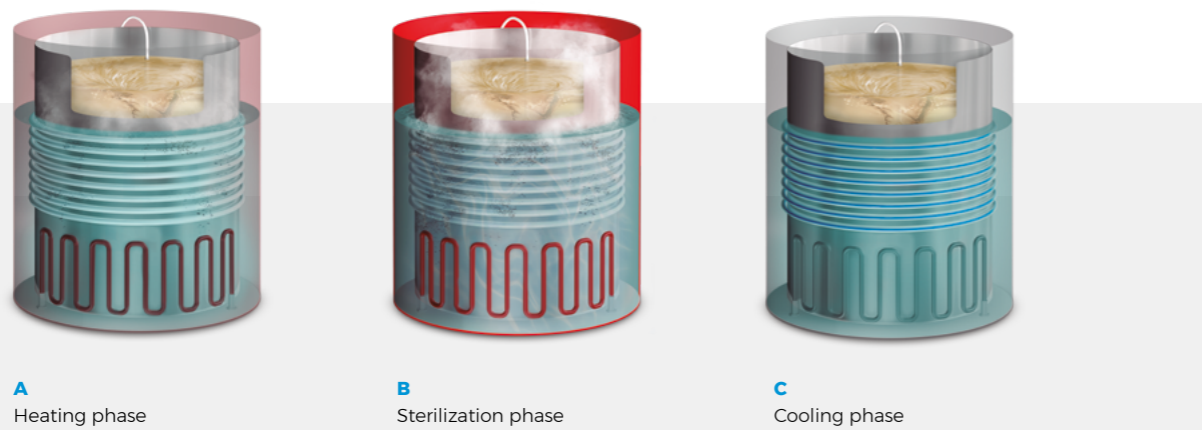
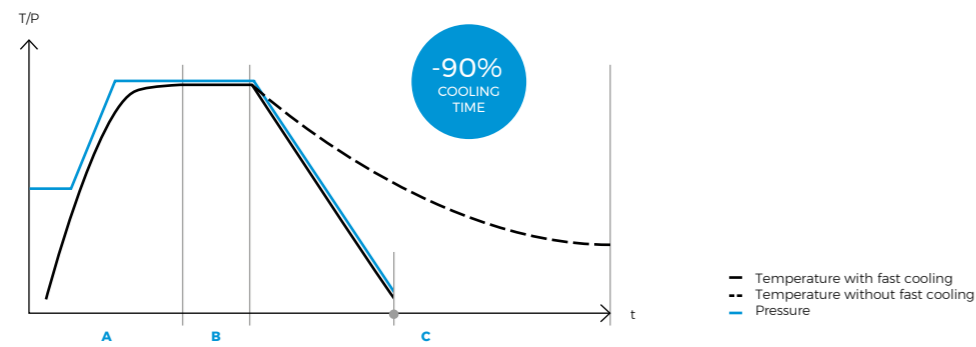

The figures presented above illustrate the three standard phases shared by all our media preparators. Moreover, the TLV-MP Series models are distinguished by a prevacuum phase that precedes the heating stage. Additionally, all models offer an optional capability that introduces pressure support at a stable value and maintained temperature during the transition from the cooling to the dispensing phase, assuming the External dosing station accessory is employed.

Automatic self-cleaning and disinfection of the dispensing lines: an exclusive design by RAYPA

All our models include multiple automatic cleaning processes to save time and minimize the risk of cross-contamination.

Before dispensing

Prior to the initiation of the sterilization phase, the dispensing lines undergo an automatic self-disinfection process by the application of continuous steam, designed to reduce the likelihood of contamination.

During dispensing

Takes away the worry of the culture medium becoming solid during pauses in dispensing by using pressurized air to clear the dispensing lines. This innovation provides the freedom to pause for necessary breaks, with the ability to resume operations seamlessly afterward.

After dispensing

At the end of each day, turn on the P1 CLEANING program. This process cleans the chamber and injects steam into the dispensing lines to dissolve any leftover residues and disinfect them, ensuring their readiness for the next day's use.

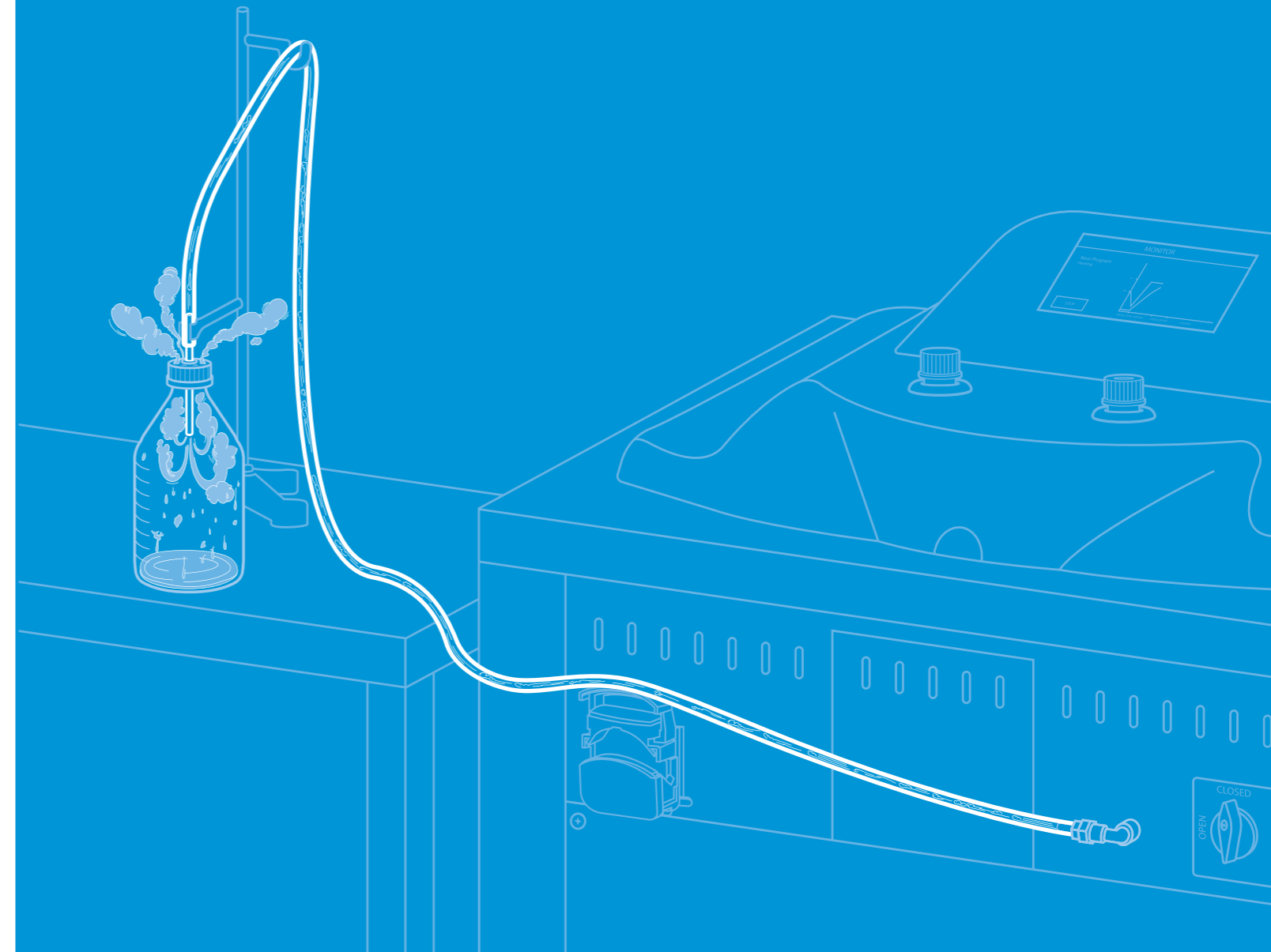

Expert media preparator

TLV-MP Series

Top line media preparators are equipped with the most advanced connectivity on the market and conform to the latest electronic record-keeping and data governance standards, enabling a totally paperless workflow that complies with FDA, GMP, and GLP regulatory frameworks.

- **Safe and effortless handling**

Features a mechanically assisted door operated by push-button for effortless opening and closing, and casters equipped with brakes for convenient mobility.

- **Faster preparations**

Up to a 90% reduction in the cooling phase duration thanks to the fast cooling system. Additionally, all models are overpowered to shorten the duration of the heating phase.

- **Enhanced performance**

Provides exceptional culture media output per cycle, with the ability to modify dispensing speeds from 7 to 100mL/s.

- **Dual functionality**

Operates as both an autoclave and a media preparator, offering savings in terms of both cost and space efficiency.

- **Precise sterilizations**

Programs adjustable by time and temperature or by F_0 , with the option of temperature control via a flexible probe or directly in the chamber.

- **Exceptional build quality**

Sterilization chamber and inner vessel made of AISI-316L stainless steel, external housing made of AISI-304 stainless steel and heating elements made of Incoloy®825.



"It can be used as an autoclave and as a media preparator"



TLV-MP Series

Total control, advanced technical assistance and professional traceability

The expert media preparator redefines efficiency in centralized quality management.



Capacitive screen, control over all parameters, real-time program visualization, user control, and access to protocol history.



Centralized management, customized reports, integrated device management, alerts, traceability for audits, and SSL encryption. Possibility of integration on private server through Docker, on Active Directory or LIMS.



Advanced technical assistance. Request for technical assistance and scheduling appointments through the controller, screen sharing via TeamViewer®, and remote diagnosis of equipment status.



Modern and ergonomic design



Standard media preparator

AE-MP Series

Classic line media preparators represent a more accessible option for customers looking for greater technological simplicity, while maintaining the quality and performance of the TLV-MP Series.

- **Faster preparations**

Up to a 90% reduction in the cooling phase duration thanks to the fast cooling system. Overpowered models available to shorten the heating phase duration.

- **Enhanced performance**

Provides exceptional culture media output per cycle, with the ability to modify dispensing speeds from 7 to 100mL/s.

- **Exceptional build quality**

Sterilization chamber and inner vessel made of AISI-316L stainless steel, external housing made of AISI-304 stainless steel and heating elements made of Incoloy®825.

- **Precise sterilizations**

Programs adjustable by time, temperature, or F_0 with the option of temperature control via a flexible probe or directly in the chamber.

- **Extensive model range**

Includes six models in the lineup, comprising two benchtop and four vertical types, with chamber capacities ranging from 10 to 175 liters.

- **Safe and effortless handling**

Casters with brakes on all vertical models for easy mobility. Benchtop models include a stainless steel table that also features casters with brakes.

"Same procedure,
simplified technology"



All media preparators from the AE-MP Series are CE marked

AE-MP Series

Integrated magnetic stirrer adjustable from 50 to 200rpm



Classic design focused on safety and practicality



Accessories

General accessories



Eco-efficient water purifier

Direct production reverse osmosis water purifier for feeding the sterilization chamber.

Ref. ECOPUR-MP



Automatic water filling

Water pump for automating the supply of the sterilization chamber with purified water in facilities lacking a pressurized network.

Ref. KLL-MP



Table for media preparators

Stainless steel table for placing benchtop media preparators or the CAR-MP dispensing system at an optimal height.

Ref. TABLE-MP, TABLE-CAR-MP



External probe for qualification

Set of reader and two specific temperature probes for performing the calibration or qualification of media preparators.

Ref. TP-VAL-MP



External probe adapter

Installation of an adapter that allows access for an external temperature probe.

Ref. CAP-MP



High viscosity paddle system

Installation of a tangential flow paddle system, designed for applications involving the processing of high-viscosity solutions.

Ref. ULTRA-STIRR



Embedded thermal printer

It prints the program number, cycle number, temperature, duration, date and time and error messages.

Ref. IT/MP, IT/TLVMP



External dot matrix printer

It prints the program number, cycle number, temperature, duration, date and time and error messages.

Ref. ITS-MP



Dispensing lines

Silicone dosing tubes 2m in length with press-fit connection and metal nozzle. Diameters available: 3,2; 4; 4,8; 6,4 and 8mm.

Ref. TUB-DOSIF

Specific accessories for the AE-MP Series

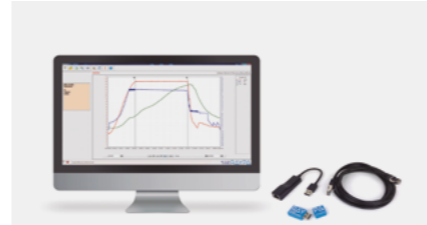

SWMP Software

Communication software between the equipment and the PC that allows the visualization and registry of the information of each cycle.

Ref. SWMP



Compressed air system

Pressure support system to enable dispensing via the external dosing station DW-MP-TS in units smaller than 60L. Larger models already include it.

Ref. CP-MP

Specific accessories for the TLV-MP Series



Professional management of digital quality

We offer multiple options for managing the digital quality of both the microprocessor and the RAYPACloud software, tailoring our solutions to the specific needs of each customer.

We provide cloud-based modalities that enable all connectivity functions and centralized off-site management. Likewise, we offer private solutions on a local server that complies with FDA 21 CFR Part 11 standards, including integration on a private server via Docker, on Active Directory or within LIMS.

Our technical team provides specialized support and custom solutions to facilitate perfect integration, as well as qualification services to ensure the functionality and security of each setup.



External dot matrix label printer

Individual labels can be printed with barcodes and identification data for each processed load.

Ref. ITS-LAB



Barcode scanner

Reads individual labels from each processed load and identifies each batch.

Ref. BAR-SCAN

Accessories

Dispensing accessories compatible with all models

Automatic system for dispensing culture media

Accessory recommended for microbiology laboratories seeking to escalate their production of Petri dishes.

This system stands out for its ability to execute multiple processes automatically and for its safety measures: the dispensing area is protected by a safety cover and an UV-C lamp that ensures the sterility of the filling area.

The system's dispensing capacity spans from 1 to 1000mL with a precision of less than 2%, and it is offered in four models that can accommodate 101 to 241 Petri dishes, with diameters of 60 or 90mm.

Ref. CAR-MP



References	CAR-MP-110/60	CAR-MP-110/90	CAR-MP-280/60	CAR-MP-280/90
External dimensions L x D x H mm	600 x 610 x 650	600 x 610 x 650	600 x 610 x 990	600 x 610 x 990
Total weight Kg	50,5	50,5	53	53
Power W	350	350	350	350
Voltage V	110 - 220	110 - 220	110 - 220	110 - 220
Frequency Hz	50/60	50/60	50/60	50/60
Total capacity of Petri dishes u	101	101	241	241
Compatible Petri dishes diameter* mm	60	90	60	90
Dispensing volume ml/Petri dish	1 - 99	1 - 99	1 - 99	1 - 99
Flow rate ml/min	600	600	600	600
Maximum productivity u/h	500	500	500	500

*Through the intervention of an authorized technician and the acquisition of the necessary components, it is possible to modify the size of compatible Petri dishes from any Ø60mm model to Ø90mm and vice versa.

Accessories

Dispensing accessories compatible with all models

External dosing station

Accessory recommended for automating and accelerating the dispensing phase in repetitive operations involving medium to large volumes.

Distinguished by its accuracy and an intuitive touchscreen interface, this system simplifies the setup of dispensing parameters across various programs at different speeds and volumes.

Compatible with Ø6.4mm dispensing lines, there are two mechanisms available for triggering each dispensation: either manually using a foot pedal or through a semi-automatic process activated by an optical sensor. Moreover, the system is engineered to allow dispensing through barriers such as glass or walls, making it perfectly suited for sterile settings such as laminar flow hoods or clean rooms, regardless of their proximity to the media preparator's location.

Ref. DW-MP-TS



Reference	DW-MP-TS
Dimensions L x D x H mm	210 x 285 x 200
Weight Kg	2,85
Power W	50
Voltage V	90 - 250
Frequency Hz	50/60

*Other voltages and electrical configurations available upon request.

The dispensing speed will depend on the density of the culture media and the chosen pressure support within the media preparator. As a guideline, the range of dispensing speeds is as follows:

Pressure support Bar	1	0,9	0,8	0,7	0,6
Dispensing speed mL/s	100	94	87	76	65

Accessories

Dispensing accessories compatible with all models

Additional peristaltic pump

Accessory recommended for automating and accelerating the dispensing phase in repetitive operations involving small to medium volumes.

All models come standard with a peristaltic pump, and this accessory allows for the installation of a second pump, significantly increasing the dispensing speed.

The dispensing speed achievable with this configuration ranges from 7 to 33mL/s, depending on the dispensing line size and the number of peristaltic pumps installed. There are two mechanisms available for triggering each dispensation: either manually using a foot pedal or semi-automatically through a delay.

Ref. CAB-2



Overview of dispensing speeds

Dispensing performance	Dispensing line model (Ø mm)	Dispensing speed
A single peristaltic pump	3,2	7mL/s
	4	9mL/s
	4,8	11mL/s
	6,4	15mL/s
	8	20mL/s
Two peristaltic pumps Ref. CAB-2	3,2	12mL/s
	4	15mL/s
	4,8	18mL/s
	6,4	25mL/s
	8	33mL/s
External dosing station Ref. DW-MP-TS		65mL/s (0,6Bar)
		76mL/s (0,7Bar)
	6,4	87mL/s (0,8Bar)
		94mL/s (0,9Bar)
		100mL/s (1Bar)



"Optimize your dispensing workflow and take your productivity to the next level"

"RAYPA MEDIA PREPARATORS OFFER AN EXCELLENT QUALITY-PRICE RATIO"



Interview with Luis Fernando Portillo Pedraza, Production Manager of the Microbiology Laboratory at Eurofins Scientific Madrid.



About Eurofins Scientific

Eurofins Scientific is a leading global entity in the laboratory industry, providing an extensive array of analytical and scientific services to enterprises in the pharmaceutical, agri-food, environmental, biotechnological, and consumer goods sectors. Globally, it has more than 61,000 employees distributed across 940 laboratories in 59

countries and offers over 200,000 types of tests in its catalog. The laboratory led by Luis Fernando Portillo belongs to the *Food & Feed Testing* division, which maintains multiple locations in Spain, including Barcelona, Madrid, Pamplona, Murcia and Tenerife, among others.

Country:
Spain

Field:
Microbiological tests in food samples

RAYPA Media preparators:
3 AE-40-MP models

Acquisition dates:
2018, 2019 and 2022

The microbiology laboratory of the Eurofins Scientific delegation in Madrid has implemented a new protocol for the preparation of culture media, essential in their daily operations. This laboratory has a total of three 40L AE-MP Series media preparators that play a crucial role in the production of large volumes of peptone water.

"We save time, space, and labor"

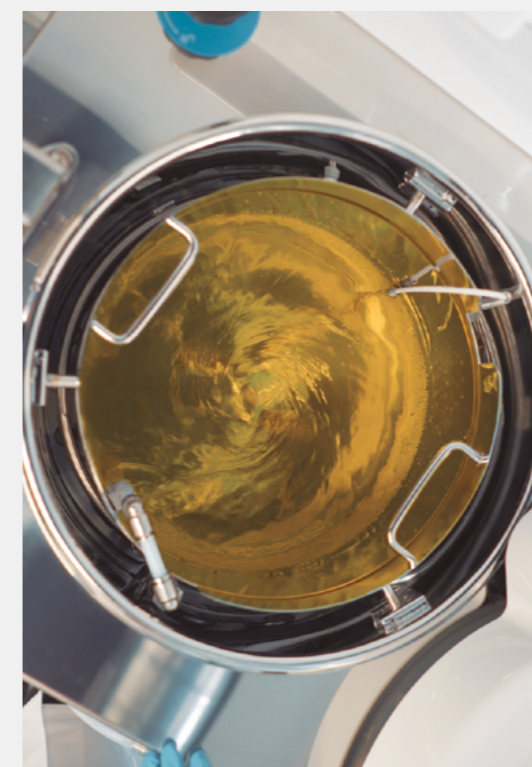

The strategy adopted to maximize productivity involves a rotational use of these devices. Each of the media preparators is assigned a specific task at any given time: media preparation, dispensing and cleaning. This rotation ensures that there is always one media preparator at each stage of the process, thus maintaining a constant workflow.

"RAYPA media preparator has the right and necessary functions to meet our needs"



[Discover more here](#)

Scan to access the full interview.

"MEDIA PREPARATORS ALLOW FOR THE RAPID PRODUCTION OF LARGE VOLUMES"

The team in charge of the micropropagation laboratory at Oriental Aquarium shares their experience with our media preparators.



About Oriental Aquarium

Founded in 1968, Oriental Aquarium is dedicated to the production and distribution of products for aquariums, terrariums, and ponds. It is one of the leading suppliers in the industry, serving renowned brands and professional growers. Based in Singapore, the company distributes its

products worldwide and has subsidiaries in different regions of Asia, Australia, Europe and the United States. The company's primary focus is on producing and supplying aquatic plants cultivated through traditional and plant tissue culture methods.

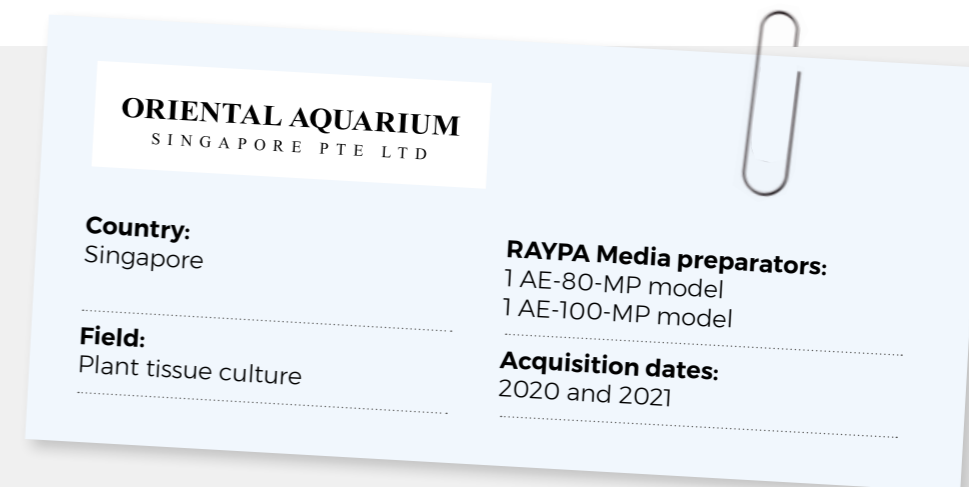

The micropropagation laboratory at Oriental Aquarium, based in Singapore, stands out for its innovative approach and eco-conscious practices in the production of aquatic plants. Housing two RAYPA media preparators, sized at 80L and 100L respectively, the facility efficiently prepares large batches of semi-solid substrate. This substrate, composed of agar, growth regulators and other additives, is essential for the optimal development of plants.

"It's a really easy-to-use tool"

Tessa Hamid, Management Associate at Oriental Aquarium's micropropagation laboratory in Singapore.



"Acquiring a media preparator is a valuable investment in case of high-volume production"

Satwant Kaur, Laboratory Technician at Oriental Aquarium

By partnering with our R&D department, their laboratory has been able to optimize efficiency and precision in its processes by implementing a customized dispensing system equipped with four peristaltic pumps.



[Discover more here](#)

Scan to access the full interview.

"WE HAVE MANAGED TO INCREASE CULTURE MEDIA PRODUCTION WITH HALF THE WORKFORCE"

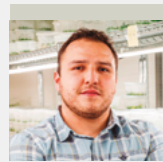

Gustavo Zúñiga, Production Deputy Manager at the biotechnology company Botanical Solution, shares insights into how our media preparator has boosted productivity within his organization.

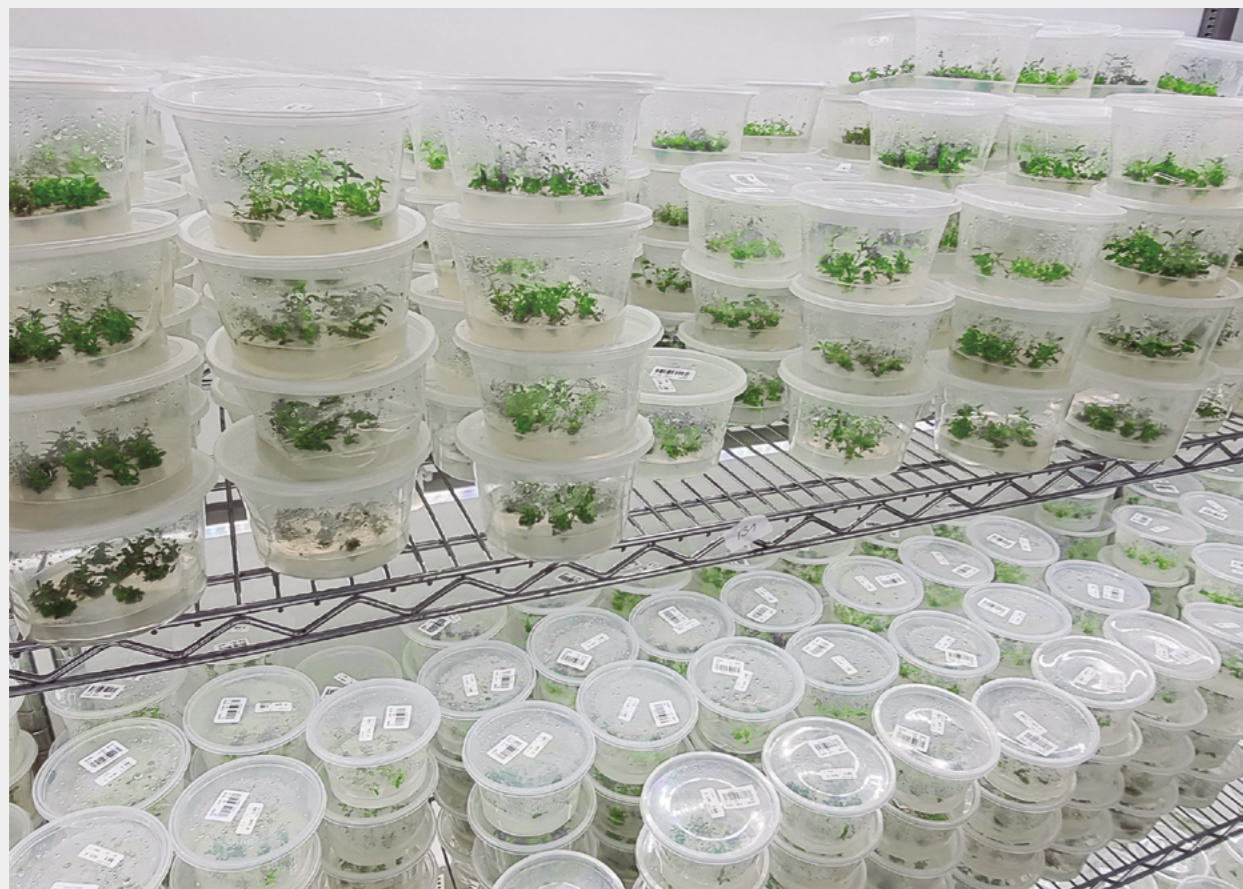

About Botanical Solution

Botanical Solution is a biotechnology company based in Chile whose purpose is to improve people's lives and the planet through the development of reliable, innovative and sustainable solutions based on science and learning from nature.

They develop products for the protection of agricultural crops and human health, by producing botanical raw materials using proprietary plant tissue culture technologies.

Botanical Solution

Country:
Chile

Field:
Biotechnology

RAYPA Media preparator:
1 AE-100-MP model

Acquisition date:
2022

"We have tripled our Quillay production"

Botanical Solution has emerged as a pioneer in the *in vitro* cultivation of Quillay, an endemic plant of Chile. Through their innovative approach, they have achieved consistent quality in production over time.

Furthermore, their method has led to a reduction in the requirement for vast land, deforestation, water consumption, and carbon emissions.



"The media preparator ended up being crucial because it helped us reduce the demand for labor"

With the aim of increasing their production of culture media, the company opted for our media preparators. Presently, they operate a 100L AE-MP Series media preparator, which has tripled their output while reducing labor demands by over fifty percent. Previously, manual production necessitated a team of 8 to 10 individuals per shift, whereas with the media preparator, only 3 people are required.



[Discover more here](#)

Scan to access the full interview.

We are the perfect partner for your laboratory

Tailored consultancy

From our initial start-up offer to carrying out maintenance or supplying spare parts, our team will accompany you every step of the way, ensuring a comprehensive and personalized solution tailored to your requirements.

Global network of technical service providers

We have an excellent in-house technical service and a network of authorized local technicians spread across the globe who undergo regular factory training.

After-sales services

We offer a full range of services to ensure a satisfactory user experience throughout the entire lifespan of our products.



Support and training programs



Guided start-up and qualification services



Preventive and corrective maintenance



Periodic calibration



Technical support and repairs



Documentation management



Special adaptations



Customization of accessories and tailored solutions

Thanks to our in-house R&D department, we have the capacity to meet the needs of our customers by adapting our accessories or creating specific solutions for them.

A clear example is our MP-TURBO model, a media preparator designed for applications that require the processing of high viscosity or lumpy media, such as aqueous solutions with starch, oats or other vegetable flours. Apart from structural changes to the chassis and the addition of new features, this version incorporates the ULTRA-STIRR accessory and a powerful peristaltic pump.



Models with increased power

Recommended for customers with high production demands seeking to boost productivity by shortening heating duration per cycle.

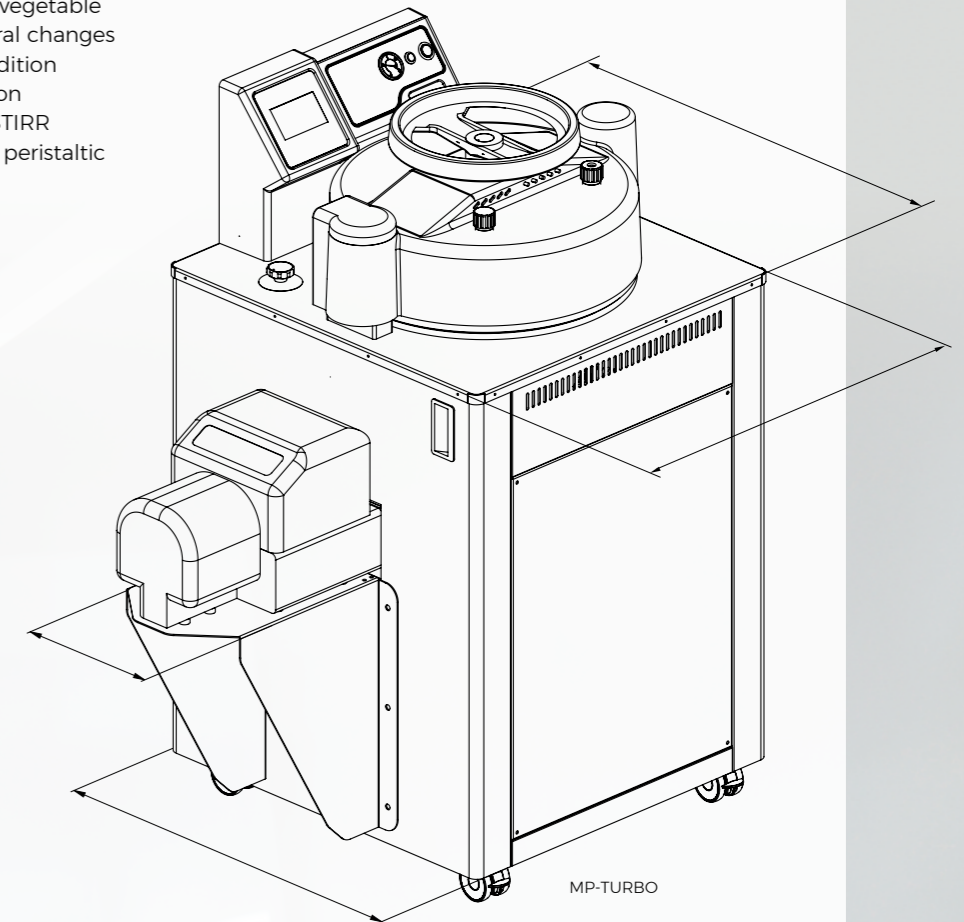

Choose your ideal media preparator

Are you an experienced user looking for a solution that offers professional traceability and centralized management?

Are you in search of a more accessible and less technologically sophisticated equipment?

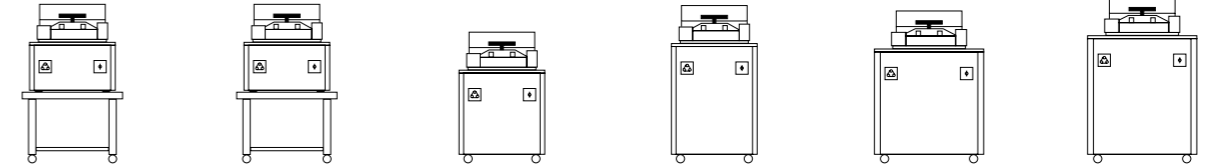
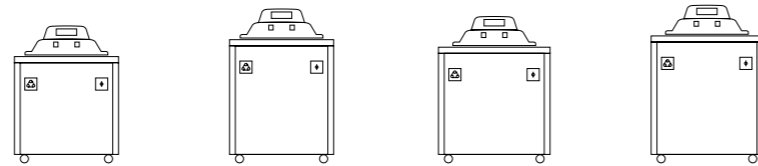

References	TLV-40MP	TLV-60MP	TLV-80MP	TLV-100MP	AE-20-MP-10L	AE-20-MP	AE-40-MP	AE-60-MP	AE-80-MP	AE-100-MP
Maximum capacity for preparing culture media L	36	54	72	90	8	18	36	54	72	90
Minimum capacity for preparing culture media* (by F ₀ or by time) L	5 or 5	10 or 10	20 or 20	20 or 20	2 or 5	2 or 10	5 or 20	10 or 30	20 or 50	20 or 70
Duration of heating phase from 25 to 121°C with max. volume min	40	55	30 - 45	35 - 55	60 - 65	70 - 75	40 - 80	55 - 80	30 - 60	35 - 80
Duration of cooling phase from 121 to 60°C with max. volume min	15 - 20	15 - 20	20 - 25	20 - 25	10 - 15	15 - 20	15 - 20	15 - 20	20 - 25	20 - 25
Total cycle duration min	70 - 80	85 - 95	65 - 90	70 - 100	85 - 100	100 - 115	70 - 120	85 - 120	65 - 105	70 - 125
External dimensions L x D x H mm	750 x 980 x 1080	750 x 980 x 1300	850 x 1080 x 1200	850 x 1080 x 1340	615 x 815 x 735	615 x 815 x 735	615 x 815 x 1100	615 x 815 x 1320	755 x 935 x 1285	755 x 935 x 1385
Inner vessel dimensions Ø x H mm	330 x 461	330 x 696	420 x 594	420 x 734	210 x 236	330 x 236	330 x 461	330 x 696	420 x 594	420 x 734
Net weight Kg	195	205	238	265	125	128	135	155	244	265
Available power options** kW	12	15	20 or 30	20 or 30	3	3	6 or 12	9 or 15	15, 20 or 30	15, 20 or 30
Standard voltage** V	400	400	400	400	230	230	400	400	400	400
Frequency Hz	50/60	50/60	50/60	50/60	50/60	50/60	50/60	50/60	50/60	50/60
Compliance with European Union regulations, including CE marking and PED	✓	✓	✓	✓	✓	✓	✓	✓	✓	✓
Compliance with regulations of the United States of America and Canada, including ASME, CRN, UL and CSA	✓	✓	✓	✓	-	-	-	-	-	-
Compliance with FDA 21 CFR Part 11 and GMP Annex 11	0	0	0	0	-	-	-	-	-	-

*On models of the AE-MP Series the minimum volume capacity is much lower if F₀-controlled sterilization is performed instead of control by time at 121°C. Contact our technical service to receive more information.
 **Other voltages and electrical configurations available on request. Special models with increased power may operate with other voltages.
 ✓: Included 0: Optional

TLV-MP Series expert media preparators



AE-MP Series standard media preparators





**NEW
VIDEO!**

Expert and
standard media
preparators



RAYPA

www.mediapreparators.com

www.raypa.com

Avinguda del Vallès, 322
08227 Terrassa (Barcelona) Spain

